

**DIMENSIONS (mm) :**

Nominal dimensions: 1800 x 38

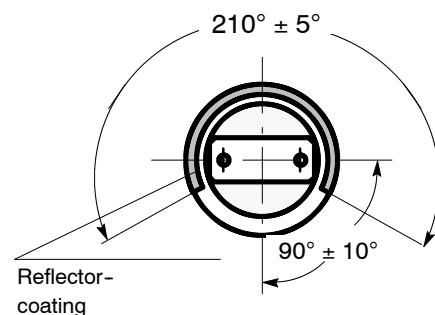
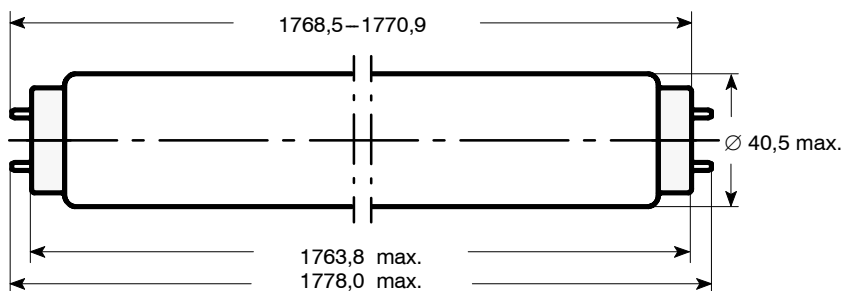

Base: G13 (IEC 61-1 Blatt 7004-51-7)

**ELECTRICAL DATA (at 25° C)**

		NOMINAL VALUE	Min.	Max.
Frequency	(Hz) :	50		
Lampe nominal wattage	(W) :	100		
Lampe rated voltage (rms)	(V) :	120	110	130
Lamp current	(mA) :	950	800	1100
Preheat current	(mA) :	1300	950	1500

**OPERATING CONDITIONS**

Cap rim temperature	(°C) :	140 Max.
Burning position	:	any
Preheat : Starter/Ballast (recommended)	:	Philips S12/Vossloh L160UV.047, Order-No. 165144, 230V/50Hz

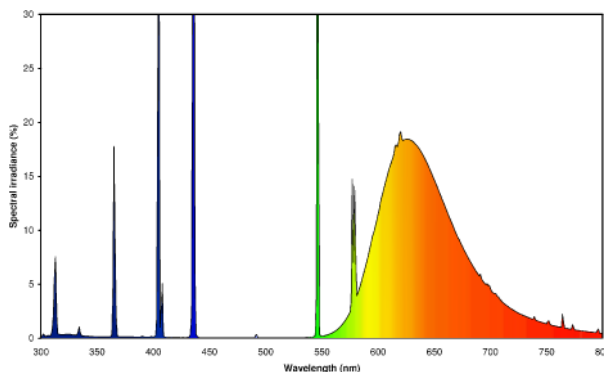

**PHOTOMETRIC DATA:**

COLOUR	Luminous Flux	CRI	Colour Temperature	ILCOS-Code
RED	***	***	***	Not suitable for general lighting use !

**REMARKS:**

Lamps comply with the requirements of EN 60081 and EN 61195, respectively.  
Starter and Ballast must comply with EN 60155, EN 60921, respectively.  
Please read and follow the user instructions.

Issued by : Havells Sylvania  
Date : 24.09.2009  
Revision Date :

**DATA SHEET**

Specification No.: 51P-6358  
Supersedes :  
Page 1 of 1